



TL431 Adjustable Accurate Reference Source

DEVICE DESCRIPTION

The TL431 is a three-terminal adjustable shunt regulator offering excellent temperature stability. This device has a typical dynamic output impedance of 0.2Ω. The device can be used as a replacement for zener diodes in many applications.

FEATURES

- The output voltage can be adjusted to 36V
- Low dynamic output impedance, its typical value is 0.2Ω
- Trapping current capability is 1 to 100mA
- Low output noise voltage
- Fast on -state response
- The effective temperature compensation in the working range of full temperature
- The typical value of the equivalent temperature factor in the whole temperature scope is 50 ppm/°C

SOT-23

1. REFERENCE

2. CATHODE

3. ANODE

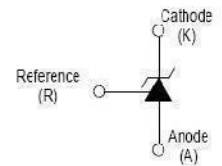
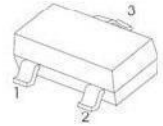

APPLICATION

- Shunt Regulator
- High-Current Shunt Regulator
- Precision Current Limiter

ABSOLUTE MAXIMUM RATINGS (Operating temperature range applies unless otherwise specified)

Parameter	Symbol	Value	Unit
Cathode Voltage	V_{KA}	37	V
Cathode Current Range (Continuous)	I_{KA}	-100~+150	mA
Reference Input Current Range	I_{ref}	0.05~+10	mA
Power Dissipation	P_D	300	mW
Thermal Resistance from Junction to Ambient	$R_{\theta JA}$	417	°C/W
Operating Junction Temperature	T_j	150	°C
Operating Ambient Temperature Range	T_{opr}	-25~+85	°C
Storage temperature Range	T_{stg}	-65~+150	°C

ELECTRICAL CHARACTERISTICS (T_a=25°C unless otherwise specified)

Parameter	Symbol	Test conditions	Min	Typ	Max	Unit
Reference input voltage (Fig.1)	V _{ref}	V _{KA} =V _{REF} , I _{KA} =10mA	2.475	2.5	2.525	V
Deviation of reference input voltage over temperature (note) (Fig.1)	ΔV _{ref} /ΔT	V _{KA} =V _{REF} , I _{KA} =10mA T _{MIN} ≤T _a ≤T _{MAX}		4.5	17	mV
Ratio of change in reference input voltage to the change in cathode voltage (Fig.2)	ΔV _{ref} /ΔV _{KA}	I _{KA} =10mA		-1.0	-2.7	mV/V
				-0.5	-2.0	mV/V
Reference input current (Fig.2)	I _{ref}	I _{KA} = 10mA, R ₁ =10kΩ R ₂ =∞		1.5	4	μA
Deviation Of reference input current over full temperature range (Fig.2)	ΔI _{ref} /ΔT	I _{KA} =10mA, R ₁ =10kΩ R ₂ =∞ T _A =-25 to 85°C		0.4	1.2	μA
Minimum cathode current for regulation (Fig.1)	I _{KA(min)}	V _{KA} =V _{REF}		0.45	1.0	mA
Off-state cathode Current (Fig.3)	I _{KA(OFF)}	V _{KA} =36V, V _{REF} =0		0.05	1.0	μA
Dynamic impedance	Z _{KA}	V _{KA} =V _{REF} , I _{KA} =1 to 100mA f≤1.0kHz		0.15	0.5	Ω

Note: T_{MIN}=-25°C , T_{MAX}=+85°C

CLASSIFICATION of V_{ref}

Rank	0.5%	1%
Range	2.487-2.513	2.475-2.525

Figure 1. Test Circuit for V_{KA} = V_{ref}

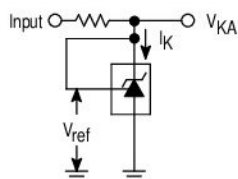

Figure 2. Test Circuit for V_{KA} > V_{ref}

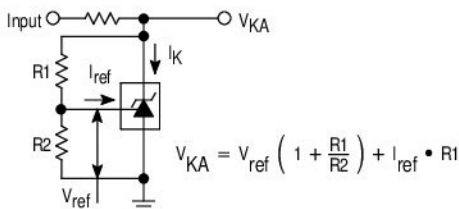
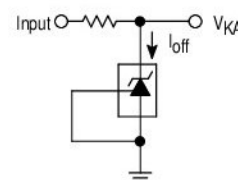
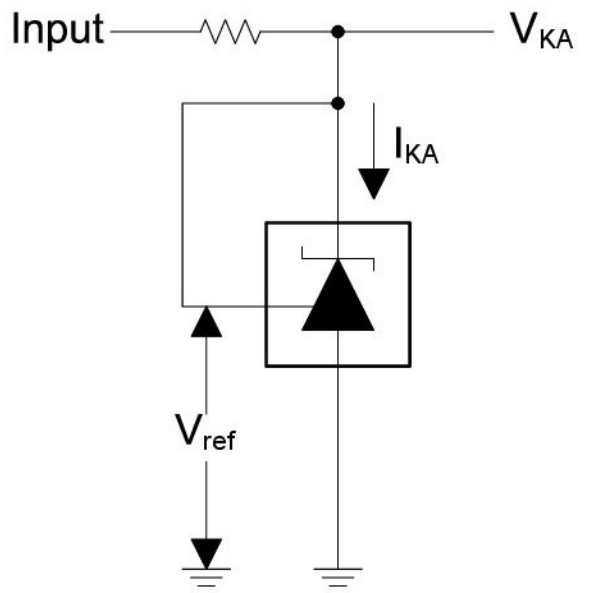
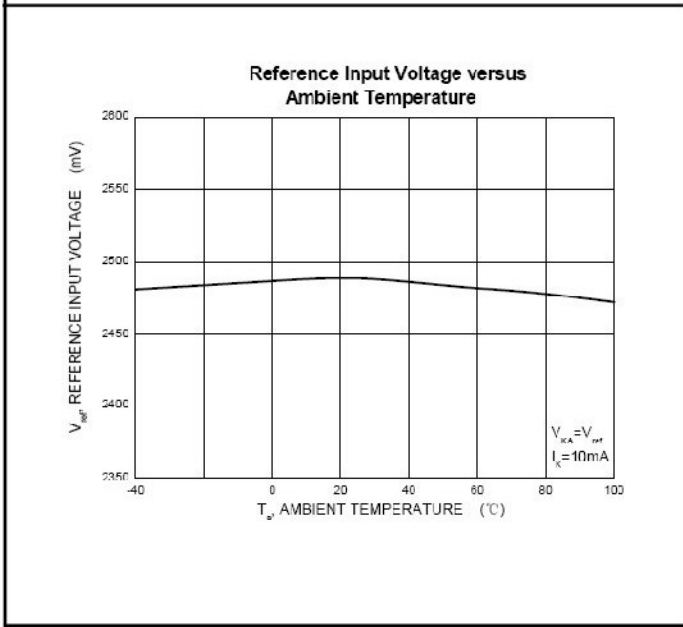
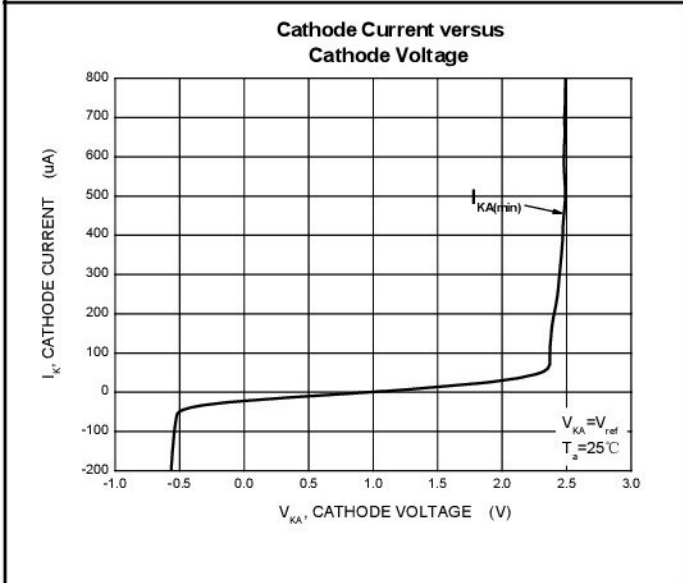
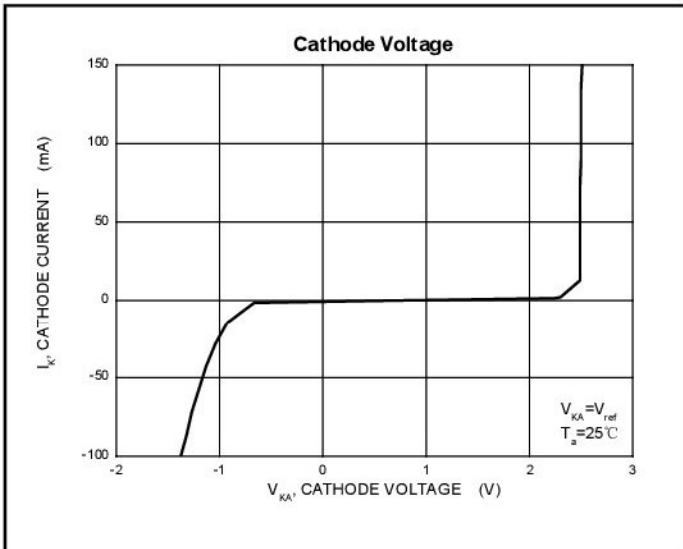

Figure 3. Test Circuit for I_{off}



Typical Characteristics



Test Circuit for $V_{KA}=V_{ref}$

Typical Characteristics

